

**NANT 34th Annual National
Symposium**

**Technology Trends
in Dialysis Water
Treatment for the
Future**



Burke A. West, P.E., MWS



Outline of Presentation

- ❑ “Typical” Hemo Water Treatment System Today
- ❑ Likely Future Hemo Water Treatment System (based on current technology and economics)
- ❑ Basis for predicted water treatment system

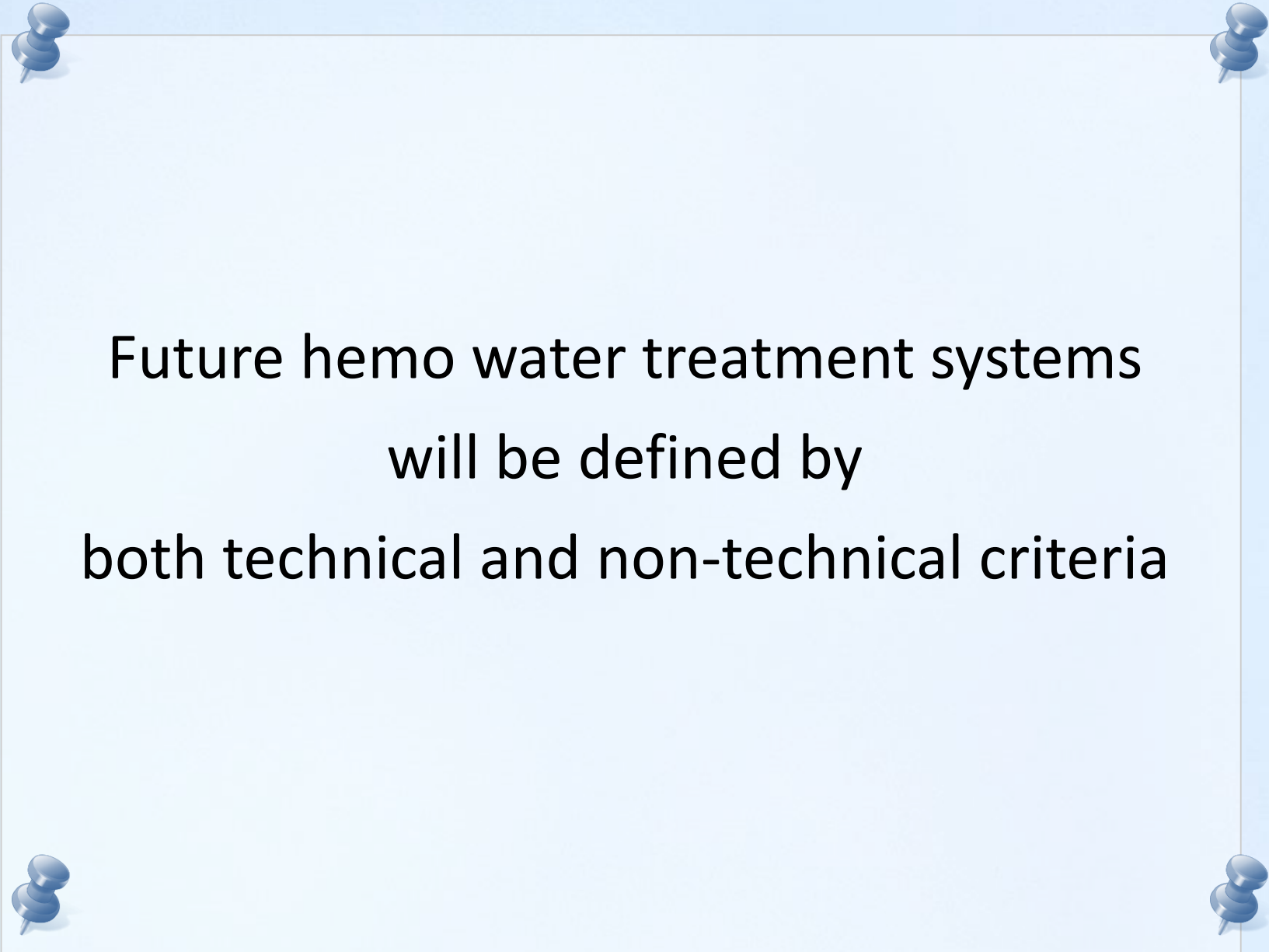



Future hemo water treatment systems
will be defined by
both technical and non-technical criteria



Basis for Predicted Water Treatment System

- Better Utilization of water technology
- Better patient safety
- System Integration
- Considering non-technical factors (forces)
 - Sustainability/CSR/UN17SDGs
 - Economics (bottom line)





Sustainability*

[*suh-stey-nuh-bil-i-tee*]

Noun

1. The ability to be sustained, supported, upheld, or confirmed.
2. *Environmental Science*. the quality of not being harmful to the environment or depleting natural resources, and thereby supporting long-term ecological balance.

*www.dictionary.com

There is no universally accepted definition for sustainability





Kinds of Sustainability

- Technical Sustainability
- Non-Technical (Social Responsibility)



Sustainability Management

For products/systems includes:

- Minimum use of natural resources
- Requiring a minimum amount of energy
- Producing a minimum impact on the environment
- For the whole life cycle of the product





Sustainability –Corporate Social Responsibility (CSR)

- ❑ Companies all over the world are coming under pressure to define and follow CSR Programs.
- ❑ The reasons are many as companies begin to recognize that they are part of the global community and that they must do their part as responsible citizens to society, community, employees and other stakeholders.



continues



continues

- ❑ A critical part of corporate sustainability is towards its stakeholders. Thus the “bottom line” is of critical importance to the long term health of the corporation.



continues



continues



**Bibliography on the subject of
Sustainable water resources management and transformation**

Oldenburg, March 2009

Ulrich Scheele
Arbeitsgruppe für Regionale
Struktur- und Umweltforschung GmbH (ARSU)

Typical Hemo Water Treatment System Today

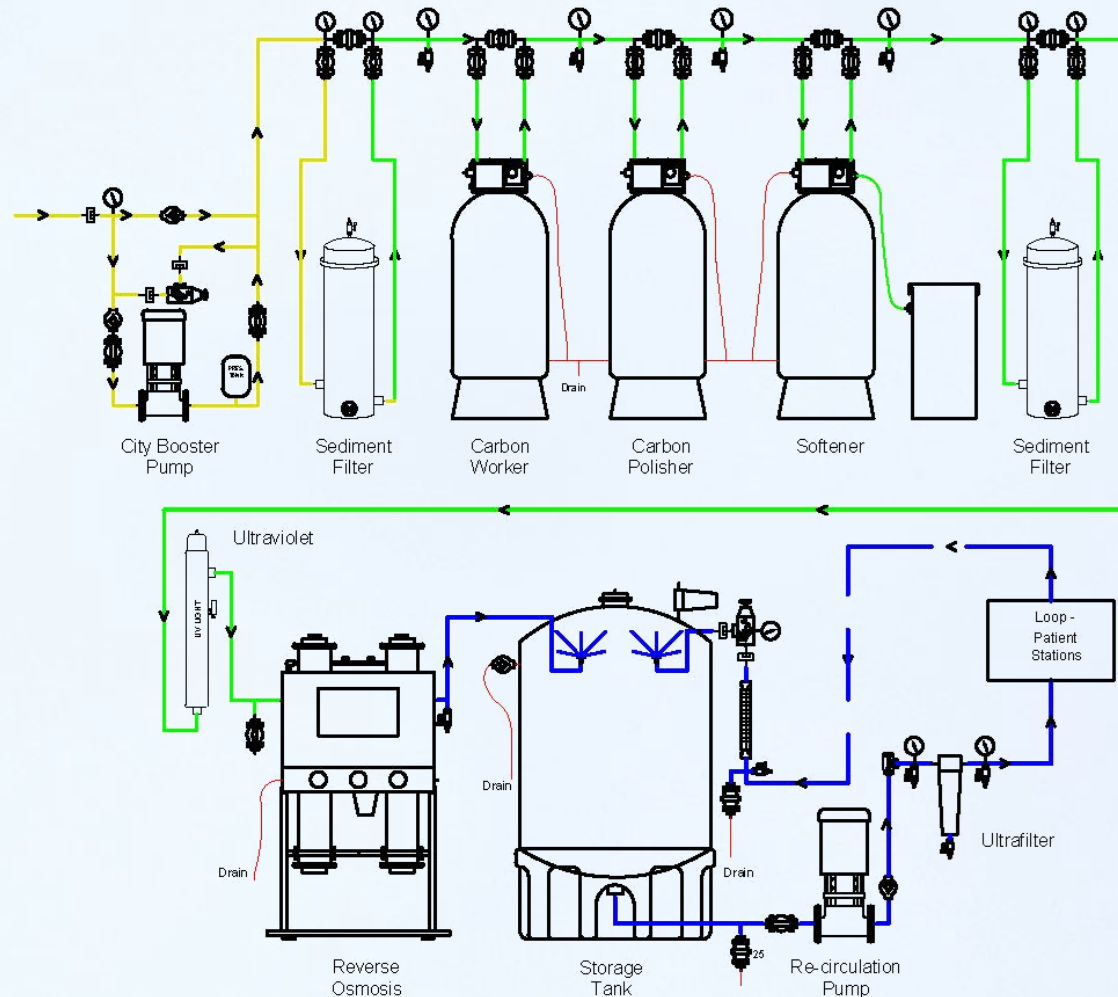

Future Hemo Water Treatment System

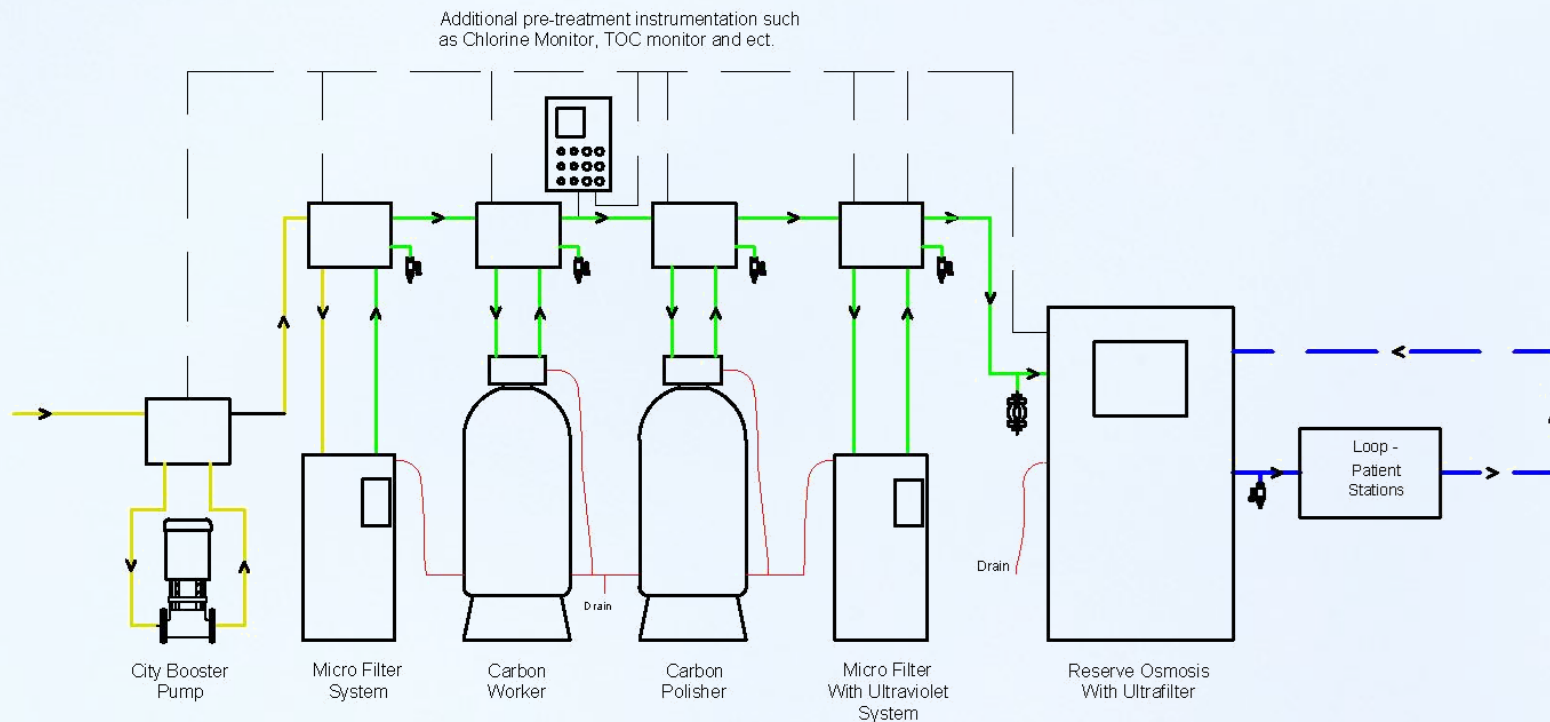

Basis for Predicted Water Treatment System

➤ *Better utilization of water technology*

- Better patient safety
- System Integration
- Considering - Sustainability/CSR/UN17SDGs
- Economics (bottom line)

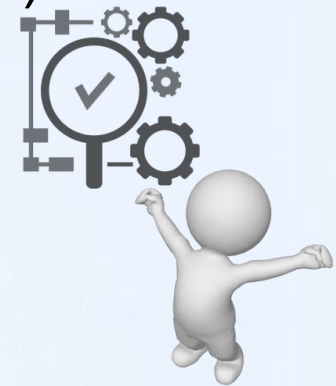



Better Utilization of Water Technology

1. Particulate (Sediment) Filtration
2. Precipitation removal (scaling reduction)
3. Microbiological control
4. Improved sustainability (Corporate Social Responsibility CSR)





1. Particular (Sediment) Filter

- Particulate comes in all sizes (sand grains to sub-micron silt).
- Quantifying particulate is done by particulate size distribution in which the amount of particulate is recorded for different size ranges.
- In hemo water treatment systems particles come from two sources:
 - I. Incoming municipal water supply
 - II. Backwashing of carbon beds





I. Incoming municipal water supply

- ❑ Lulea University of Technology in Sweden has done one of the most comprehensive studies of particulates in municipal water. Conclusions:
 - Delivered particulates are submicronic
 - Many sources – from water treatment process, distribution system contamination
 - ❑ Same results in USA for problematic water submitted for particle size distribution analysis – amount of sediment varies but the distribution of particle size does not.
- 
- 

Sediment Filtration Technology for Incoming Municipal Water

Technology	Filter	Filter Sediment Range	Sustainability	Efficacy
Old	Multimedia	> 20 – 40 μm	1,000 gal/BW	Big Zero
Current	Multi-cartridge	< 1 μm	Cartridge one time use	High
Future	Membrane (MF)	< 0.1 μm	Highest/BW controlled by PD	Best

* When properly maintained (cartridges only changed when pressure drop exceeds set-point)



II. Carbon Fine Particulate

- This is the number one underappreciated issue in hemo water treatment systems today
- Backwashing carbon beds is a disaster for all components of the water treatment system downstream.



continues



continues

- ❑ Backwashing granulated activated carbon (GAC) causes the tumbling granules to rub against each other and as they are abrasive, they scrape off small chips (carbon fines). These carbon fines are compacted into the carbon bed when the bed is forward rinsed and then slough off into the water over the next service cycle backwashing carbon beds is a disaster for all components of the water treatment system downstream.



continues



continues

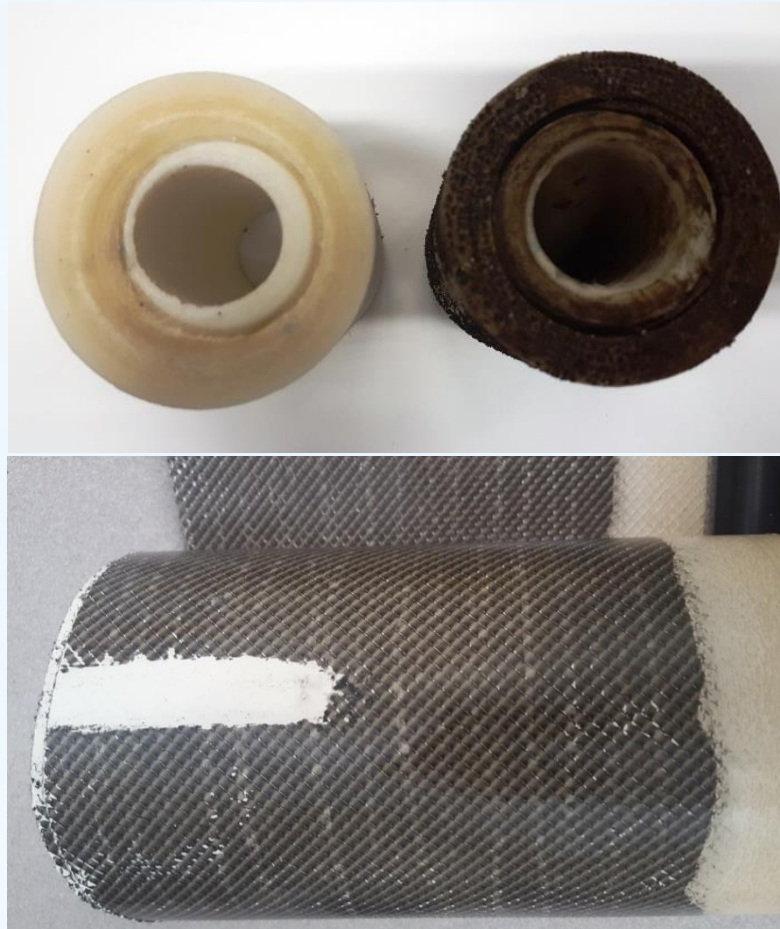

continues



continues

- ❑ Ironically, carbon beds are backwashed to clean them of the incoming sediment from the municipal water. Instead backwashing the bed introduces the silt to the bottom of the bed to be compacted along with the carbon fines during the forward rinse.
- ❑ Stopping backwash or significantly reducing the backwash of carbon tanks when properly protected by effective pre-treatment sediment filtration will eliminate this issue



continues



Sediment Reduction Technology After Carbon Beds

Technology	Pre-Sediment Filter	Carbon Bed BW Rate	Sustainability	Efficacy
Old	Multimedia	6 days/wk	6,000 gal/wk	Negative
Current	Multi-cartridge	3 days/wk	3,000 gal/wk	Maybe 0
Future	Membrane (MF)	1/Qtr	4,000 gal/yr	Best



2. Membrane Scale Reduction

- ❑ Next to not appreciating the importance of treating sediment in the water treatment system, membrane scaling is one of the most misunderstood issues in the industry.
- ❑ 30 years ago, Common knowledge: three types of membrane fouling in hemo water treatment systems:
 - I. Mineral scale fouling
 - II. Sediment fouling
 - III. Biological fouling



continues



continues

- ❑ Today, Common knowledge: only one type of membrane fouling – biological.
- ❑ It is the biological fouling that captures the sediment and is the glue for mineral scale.
- ❑ Yet, we still go along as we did 30 years ago.



continues





continues

- ❑ In 2001, Elfil and Roche showed that when the saturation index of amorphous calcium carbonate is exceeded, it will globally precipitate out of the solution (not a boundary wall phenomenon). [R. J. Ferguson and A. J. Freedman](#) published similar results in 2003.
- ❑ The AWT organization has some of the foremost world leaders in scale technology such as Paul Puckorius and Arthur Freedman. This technology is not new in the industry and has been demonstrated in many papers.



continues





continues

- ❑ Softeners will no longer be needed once the biological fouling of the membrane is eliminated

Technology	Scale Reducer	Method	Sustainability	Efficacy
Old	Softener	Ion Exchange	<ol style="list-style-type: none">1. Used if needed or not2. Uses excessive salt due to miss application3. Waste water	Poor
Current	Anti-scalant media	Minimizes precipitation	Small amount of media replaced every 3 years. No backwashing	Excellent
Future	Only if needed	Site specific	Only uses resources needed	Best



3. Microbiological Control

- Microbiological Control is important in every part of the hemo water treatment system. However, it is most problematic in two areas:
 - a. RO membranes
 - b. Patient Water Loop
- 
- 



3a. Microbiological Control for Reverse Osmosis Membranes

Technology to Control Biological Fouling of Membranes

- Sterilize the microorganisms before they reach the RO machine with UV
- Remove the carbon fines (and organics) that feed the microorganisms with a submicron filter (adequate multi-cartridge sediment filter or membrane filter)



continues



continues

- Future – membrane technology such “sharkskin surface”, anti-microbial, etc.
- Heat sanitizing of membranes



continues

Technology	Associated Equip.	Method	Sustainability	Efficacy
Old	<ul style="list-style-type: none"> ● Multimedia Filters ● Carbon bed backwashing daily 	<ul style="list-style-type: none"> ● Chemical Cleaning ● Disinfection 	<ul style="list-style-type: none"> ● Generated significant carbon fines on membranes ● Chemical disposal 	Poor
Current	<ul style="list-style-type: none"> ● Pre-multi-cartridge filter ● Fewer carbon bed backwashing ● Post-multi-cartridge filter ● Ultraviolet sterilization 	<ul style="list-style-type: none"> ● Minimizes precipitation 	<ul style="list-style-type: none"> ● Less water used for carbon bed backwashing ● Chemical disposal 	Poor to better
Future	<ul style="list-style-type: none"> ● Pre-Micro filter ● Carbon bed BW minimized ● Post-Ultra filters ● Ultraviolet sterilization 	<ul style="list-style-type: none"> ● Heat cleaning and disinfection 	Only uses resources needed	Excellent

3b. Microbiological Control for Patient Loop

Technology	Back Ground Info	Method	Sustainability	Efficacy
Old	Material: PVC80 often installed by local plumbing companies	Frequent Chem. Disinfection due to material and high variation of loop construction integrity (quality of installation)	Susceptible to large quantities of chemical needed to maintain loop water quality within national standards.	Moderate
Current	Material: Teflon or PEX	Heat	Excellent	Excellent
Future	Material: Likely the same but engineered to reduce heat transfer and permit welded installation	Heat	Excellent	Best

Basis for Predicted Water Treatment System

- Better utilization of water technology
- ***Better patient safety***
- System Integration







Better Patient Safety

1. Additional water quality monitoring
2. Patient loop design and materials







Pre-Loop Monitoring (Included Data Logging and Data Filling)

- Today the conductivity of the water at the beginning of the patient water loop is monitored
- Tomorrow in addition to the conductivity,
 - Temperature
 - Pressure
 - Flow
 - Chlorine concentrate
 - TOC concentrate

Will be monitored, logged and filed



Patient Loop Design and Material

As Previous discussed



Basis for Predicted Water Treatment System

- ❑ Better utilization of water technology
- ❑ Better patient safety
- ***System Integration***





Integration of System

- One machine (computer/PLC controlled system) with auxiliary components such as booster pump, filters, and loop plugging into it.
- Completely integrated with system computer
- Data logging and filing
- Remote accessible
- Tablet controlled



Tablet Integration System

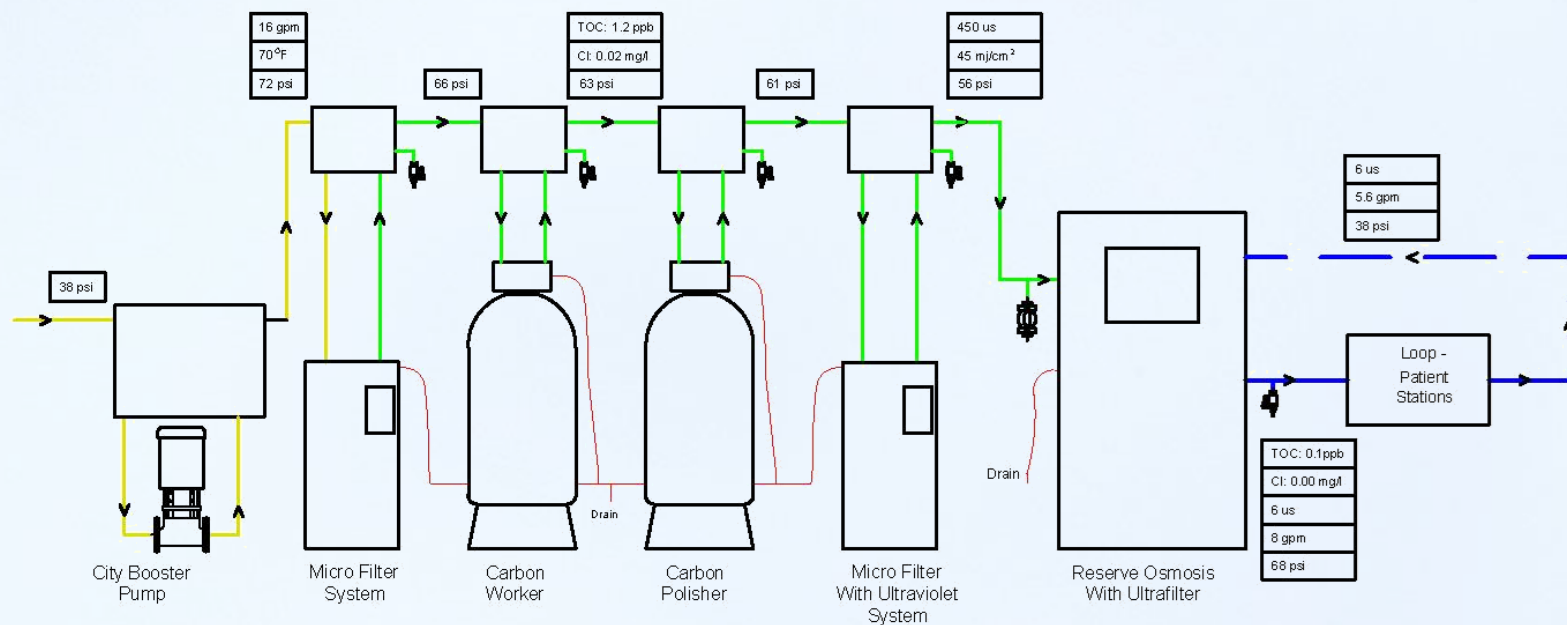

Question & Answer





Burke A. West, P.E., MWS